

NEW
RENAULT CAPTUR
E-TECH FULL HYBRID

145 hp



also available in petrol

June 2024



compact and assertive SUV

With its powerful front end panel, an esprit Alpine trim with an iconic sports design, new Renault Captur E-Tech full hybrid is very much the embodiment of a compact SUV. With generous interior space, an openR link multimedia system with Google built-in and 28 advanced driver-assistance systems, it stands out in every respect.



Enjoy the thrill of electric driving with the 145 hp full hybrid E-Tech engine.

145hp E-Tech full hybrid engine

up to 1,000 km of range⁽¹⁾

Up to 616 litres⁽²⁾ of boot volume⁽³⁾

openR link system with Google built-in

biosourced⁽⁴⁾ and recycled materials

28 advanced driver-assistance systems

(1) with a full tank of petrol according to WLTP data (including the reserve tank). (2) depending on engine and with bench seat in the forward position. (3) equivalent volume measured according to the VDA standard (ISO 3832) of 422,536 and 1,275 dm³ for the petrol version and 326,440 and 1,149 dm³ for the full E-Tech hybrid version. (the VDA standard involves measuring the total volume of the boot using standardised shape and volume objects (200 mm x 100 mm x 50 mm = 1 dm³). (4) depending on version.

interactive menu

01. design

02. on-board experience

03. driving pleasure

04. multimedia

05. interior space

**06. advanced driver-assistance
systems**

07. customisation

powerful style

Muscular front grille, streamlined headlight optics, satin shale grey F1® blade and redesigned Renault emblem. A new sharper design for an ever more inspired style.



Dark chrome emblem, new crystal rear lights, esprit Alpine signature badges on the front wings, and assertive sportiness of the 19" elixir alloy wheels exclusive to this version.

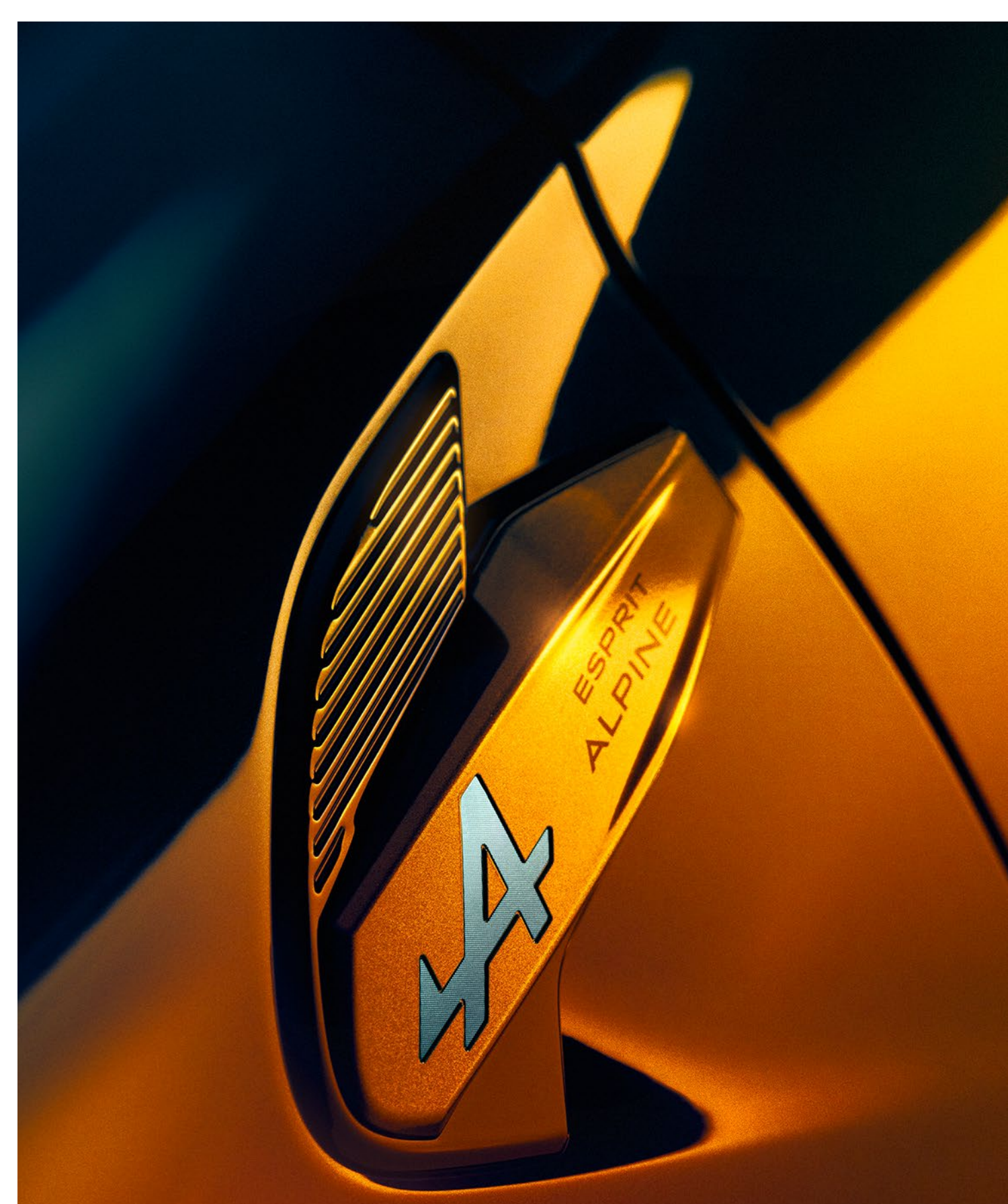

Rediscover Captur's DNA with its timeless two-tone touch. The new pearl greige roof colour enhances its 14 possible combinations.



pearl white and highland grey roof

02. on-board experience

on-board experience

Immerse yourself in its eco-chic sports interior made using recycled and biosourced materials⁽¹⁾. Select your driving style for a personalised driving experience thanks to multi-sense and its 5 modes⁽²⁾. Ultimate comfort with Harman Kardon⁽³⁾ high-fidelity sound and 9 speakers.



Thanks to wireless mirroring, all of your apps, playlists, podcasts and calls are displayed on the multimedia screen. The wireless charger always ensures an optimal level of independence.

The esprit Alpine stands out with its blue top-stitching and a steering wheel adorned with blue/white/red stitching. Each seat back features the Alpine emblem.



(1) depending on version. (2) with extended grip option. (3) available as an option on esprit Alpine and techno (only with navigation).

03. driving pleasure

E-Tech full hybrid engine

E-Tech
full hybrid
145 hp

up to
80%
electric driving
in town⁽¹⁾

up to
60 km/h
in electric mode⁽¹⁾

up to
1000 km
of range⁽²⁾

from
4.6 litres/100 km
of fuel consumption

from
105 g/km
CO₂ emissions



On the full hybrid E-Tech version, the battery recharges during deceleration and braking. In town, drive up to 80% of the time in electric mode and enjoy fuel savings of up to 40%⁽³⁾.

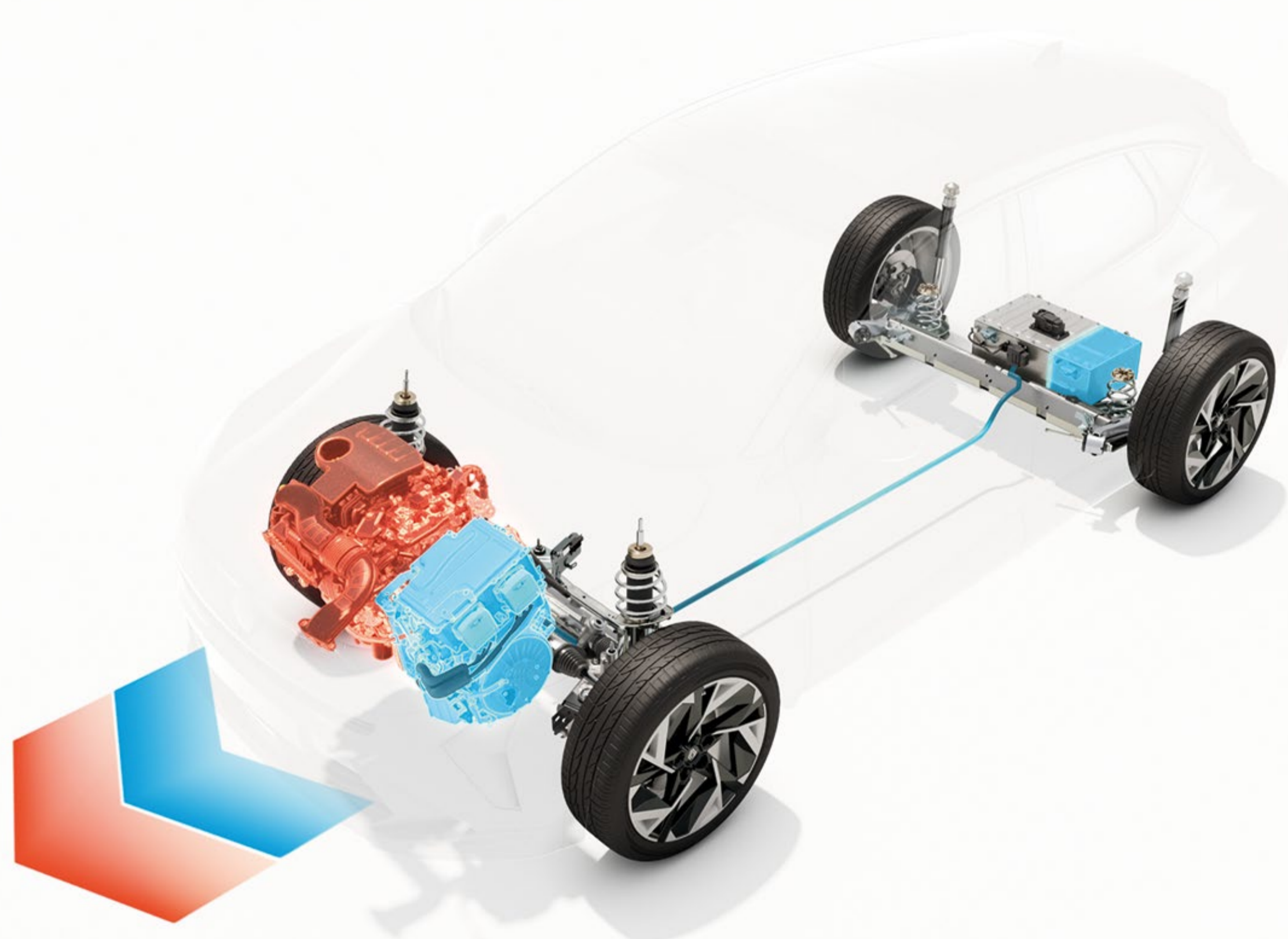

145hp E-Tech full hybrid engine

In town, enjoy fuel savings of up to 40%; drive up to 80% of the time in electric mode and without any noise, while charging the battery when decelerating or braking. No need to plug your vehicle into a power outlet.

(1) depending on the battery's charge level and driving style / Renault internal source / 2023. (2) with a full tank of petrol according to WLTP data (including the reserve tank). (3) for an E-Tech full hybrid engine compared with a mild hybrid auto engine, according to WLTP City protocol / UTAC & IDIADA source / September 2022.

openR link multimedia system with Google built-in⁽¹⁾⁽²⁾

With its new central 10.4" screen and 10.2" TFT screen⁽³⁾, the openR link multimedia system offers intuitive access to the best of Google services: navigation with Google Maps⁽¹⁾, voice assistant with Google Assistant or Google Play⁽⁴⁾ with more than 50 apps available⁽¹⁾.



Closed road, new direction of traffic, roadworks, etc. Always take the best route and let yourself be guided by Google Maps⁽¹⁾.



With Google Assistant, plan your journey, change driving mode or adjust the temperature with a simple voice request⁽¹⁾: "Hey Google..." and off you go.





Over 50 applications⁽¹⁾ with exclusive content are available via Google Play⁽⁴⁾, including Waze, SongPop for Renault, and Amazon Music.





 **Waze** is a community-based navigation app that shares information in real time. Waze boosts your peace of mind.

 Take to the road while listening to playlists, and much more, with **Amazon Music**, included with your Amazon Prime subscription.

 **Vivaldi browser** is an efficient, fast web browser that respects your privacy.

 **Kabriol** is the first audio-geolocated tourist guide for children. Hundreds of stories and geolocated information to keep you busy in the car.

 With **EasyPark**, plan and book millions of parking spaces across Europe. Enter your destination's address or navigate using the map.

 **Sybel** is a unique platform to find your favourite podcasts, and discover exclusive original creations, audio books, new documentaries, etc.

 Drive to the beat with our new musical game – **SongPop for Renault!** Play together and rediscover popular songs with your family and friends!

 Get all the latest sports news in your car with the **L'Équipe for Renault** app.

 Access all your favourite radio stations live, at any time, in France or abroad, with **Radioplayer**.

 Discover the stories around you thanks to **Karacal's** geolocated sound bubbles. Make every journey a new adventure.

 **Sybel** is a unique platform to find your favourite podcasts, and discover exclusive original creations, audio books, new documentaries, etc.

(1) depending on country, (2) My Renault, Google Maps and Google Assistant connected services are provided free of charge for 5 years from the date of delivery of your vehicle. (3) depending on version. (4) the use of applications downloaded from Google Play requires a dedicated data package. To use these apps, share your phone's connection with your Renault. You can also subscribe to a pay-as-you-go offer from our partner Orange (offer without commitment) where the first 3 GB are free (valid for 6 months). Google, Google Maps, Google News, Waze and other marks are trademarks of Google LLC.

compact and generous

The interior space can be adjusted according to your needs thanks to the ingenious 16 cm sliding rear bench seat. This gives passengers knee room of up to 22 cm. You can reduce it to free up more space in the loading area.



The boot of up to 616 L⁽¹⁾⁽²⁾ is extremely practical with its modular volume. In the blink of an eye, fold down the rear bench seat and enjoy total loading space of up to 1,596 L⁽¹⁾, ideal for transporting long objects.



(1) depending on engine and with bench seat in the forward position. (2) equivalent volume measured according to VDA standard (ISO 3832) of: 422, 536 and 1,275 dm³ for the petrol version and 326, 440 and 1,149 dm³ for the E-Tech full hybrid version. (the VDA standard involves measuring the total volume of the boot using standardised shape and volume objects (200 mm x 100 mm x 50 mm = 1 dm³).

06. advanced driver-assistance systems



28 advanced driver-assistance systems

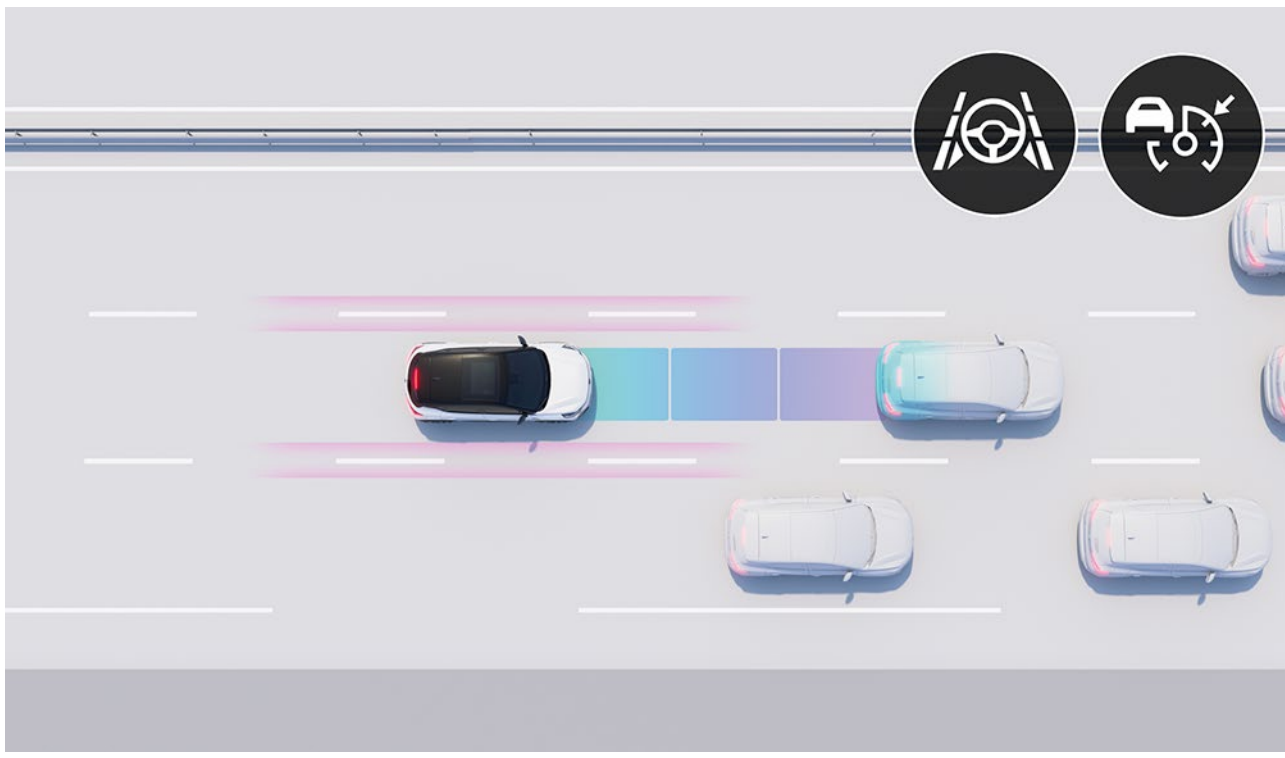

active driver assist

This system regulates your speed by taking the road environment into account, maintains safe distances and ensures you remain in lane. When traffic slows down, the vehicle stops and restarts automatically.

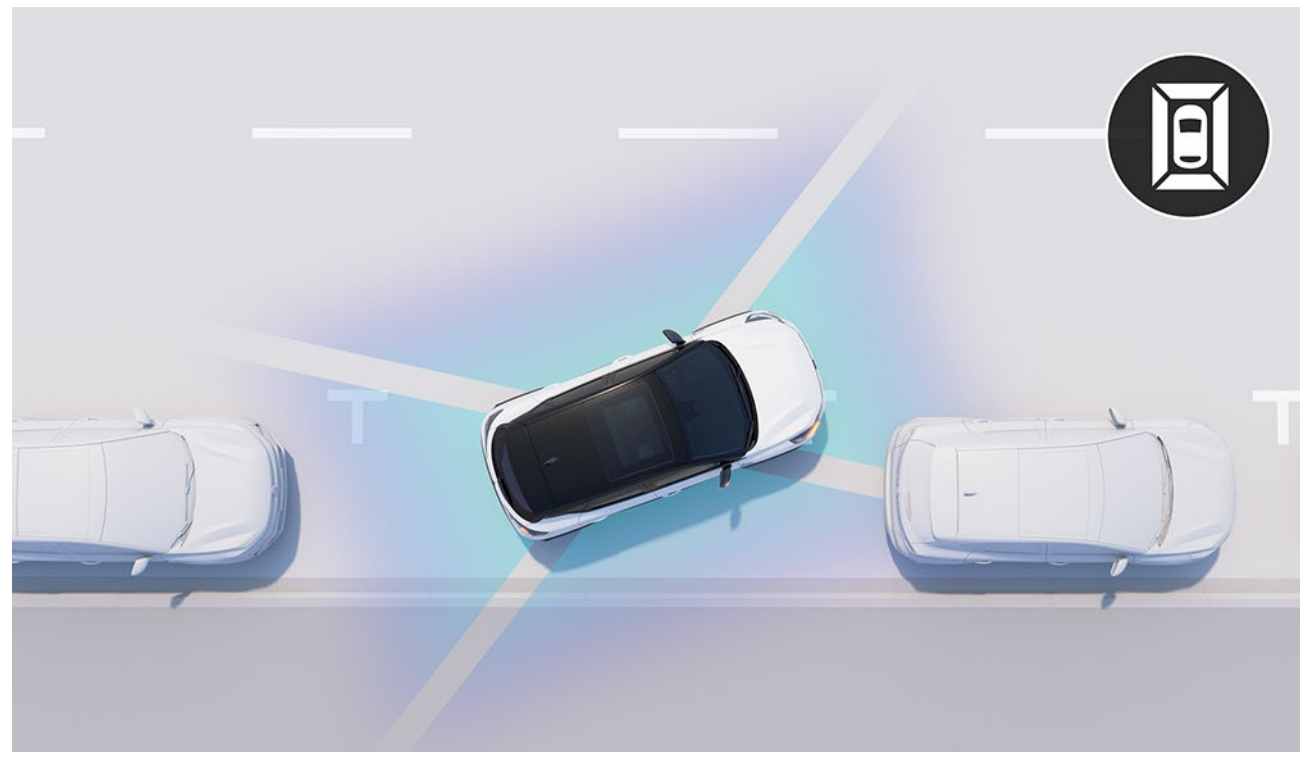

360° around view camera

The 4 cameras, whose images recreate the vehicle's direct environment 360° around it, allow you to perform your manoeuvres effortlessly.



rear parking space exit warning

The driver is warned when an object (vehicle, motorcycle, bicycle, etc.) approaches from the rear of the vehicle with a risk of collision.



predictive hybrid driving

Your car anticipates combustion-engine, hybrid or 100% electric driving by continuously analysing your route to establish the time at which you shall drive through a town or whether you risk encountering a particular topography or a traffic jam. As a result, you improve the fuel consumption and performance of your vehicle.

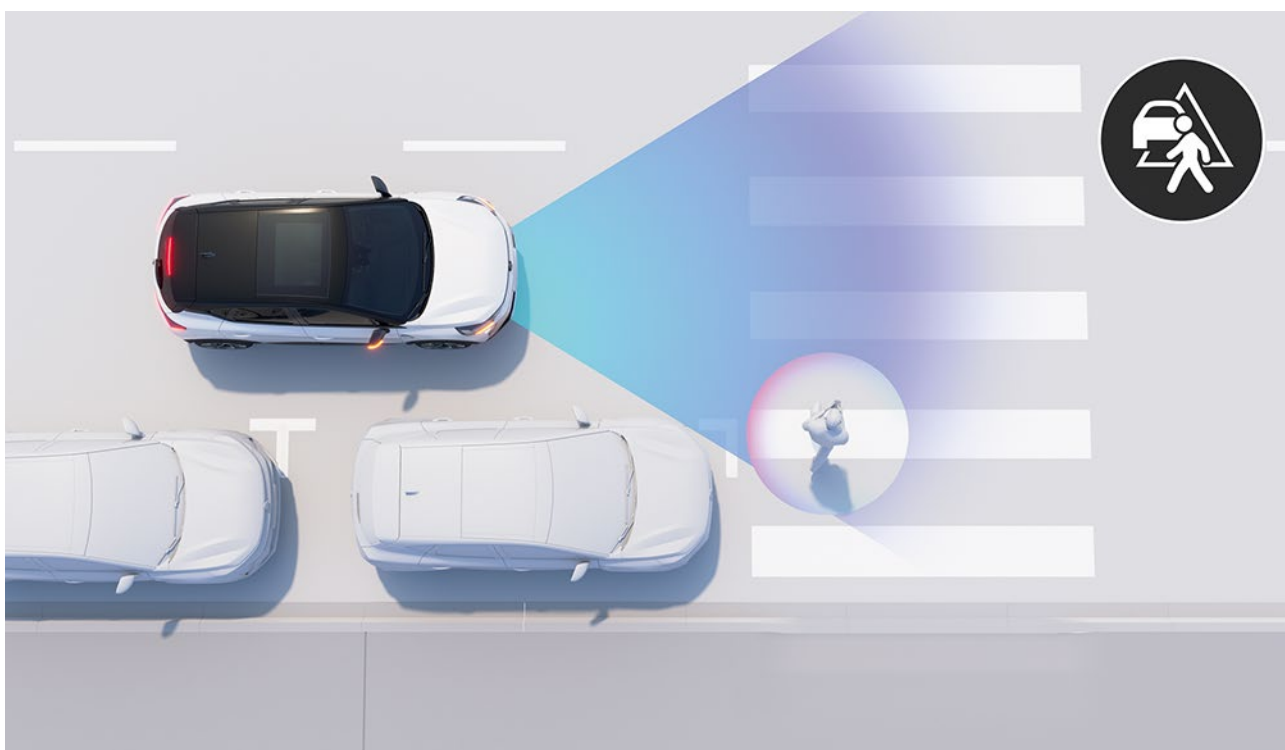

automatic emergency braking (pedestrian/cyclist)

This system detects pedestrians coming from the front or side and stops the vehicle in the event of danger. Driving in the city has never been so safe, day or night.

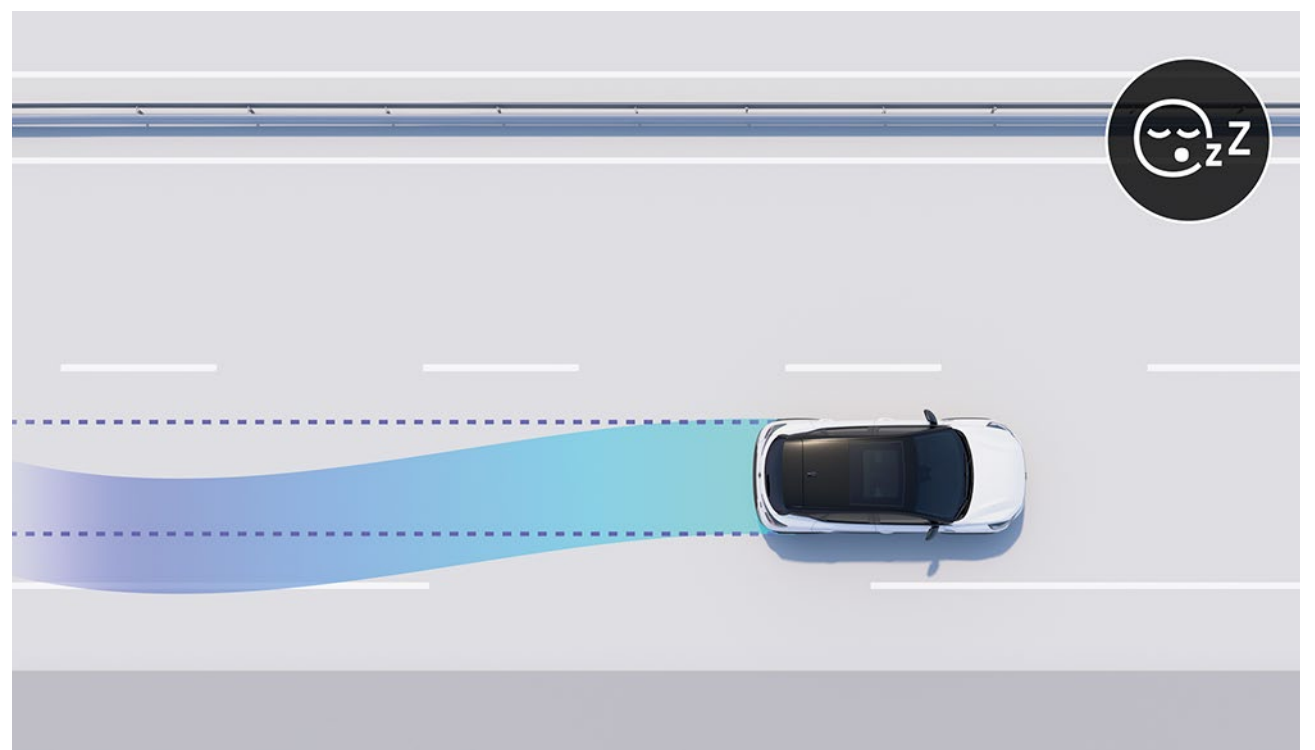

driver attention alert

The system warns the driver if they are inattentive or drowsy.

driver-assistance systems

- active driver assist
- hill start assist
- predictive eco-driving assistant
- predictive hybrid driving
- following distance
- speed limiter
- cruise control
- adaptive cruise control
- intelligent adaptive cruise control

park assist systems

- rear parking sensors
- front parking sensors
- side parking sensors
- rear view camera
- 360° around view camera
- hands-free parking

safety assistance systems

- lane departure warning
- occupant safe exit warning
- lane keeping assist
- blind spot warning
- rear cross traffic alert
- automatic main-beam/dipped headlights activation
- rear detection with lane keeping assist
- front detection with emergency trajectory correction
- automatic emergency braking at intersections
- automatic urban and inter-urban emergency braking (with detection of cars, pedestrians and cyclists)
- traffic sign recognition and speed alert
- road sign recognition
- driver attention alert

07. customisation

colours



pearl white (1)



iron blue (1)



flame red (1)(2)



ceramic grey (1)



silver grey (1)



pearl black (1)

(1) metallic paint.
(2) flame red FOC.
two tone is available from entry Evolution spec.
photos not contractually binding.

07. customisation

customisation of and door mirror casings

evolution and techno



pearl white / highland grey roof



pearl white / pearl champagne roof



pearl white / pearl black roof

colours / roof colour	highland grey	pearl champagne	pearl black
pearl white	▪	▪	▪
iron blue	▪	-	▪
flame red	-	-	▪
ceramic grey	▪	▪	▪
silver grey	▪	▪	▪
pearl black	▪	▪	-

esprit Alpine



iron blue highland grey roof



blue pearl black roof

colours / roof colour	highland grey	pearl black
pearl white	▪	▪
iron blue	▪	▪
flame red	-	▪
ceramic grey	▪	▪
silver grey	▪	▪
pearl black	▪	-

▪ available
- not available

07. customisation

interior trims



evolution

- 17" nymphéa flex wheels
- metallic grey decorative upper strip
- openR link multimedia system with 10.4" touchscreen compatible with Android Auto™ and Apple CarPlay™, Bluetooth®, USB C and jack sockets, wireless smartphone mirroring



techno (evolution +)

- 18" black hole alloy wheel rims
- granite grey decorative upper strip
- wireless smartphone charger
- automatic heating and air conditioning system



esprit Alpine (techno +)

- 19" elixir alloy wheels
- Alpine marking and red white blue flag on front seats
- lower textile sheathed strip with red white blue flag
- openR link 10.4" with Google built-in: Google Maps navigation, Google Assistant voice assistant and more than 50 apps thanks to Google Play
- floating centre console with e-shifter gear lever

Android Auto™ is a Google Inc. brand. Apple CarPlay™ is an Apple Inc. brand.

07. customisation

upholstery



embossed mottled grey assault fabric / black kario fabric with drake blue top-stitching



embossed marled black faunny fabric / marled black mellow fabric / titanium black refined biosourced textile with fresh yellow top-stitching



75% recycled jacquard madama fabric / refined bio-sourced black titanium-grain fina fabric with alpine blue top-stitching

wheels



17" nympha flex wheels



18" black hole alloy wheel rims



19" elixir alloy wheels

07. customisation

accessories



exterior customisation packs

Accentuate the dynamism and elegance of Renault Captur with the exterior pearl greige, highland grey or glossy black customisation packs. These packs cover the front/rear bumper skid plates and mirror caps⁽¹⁾.



retractable towbar

With Renault's innovative electric-towing system, you can tow a trailer or carry bikes with minimum fuss.



premium sidesteps

Emphasise the car's SUV design and also allow easy access to the roof load.



esprit Alpine floor mats

The premium quality extends to the front and rear mats with blue stitching that adds a touch of sophistication. The distinctive signature features the Alpine logo on the front mats.



high-comfort black cushions on rear headrests

For first-class travel, opt for the rear headrest cushion, which adds style and a feeling of well-being.

(1) depending on version.

dimensions and volumes

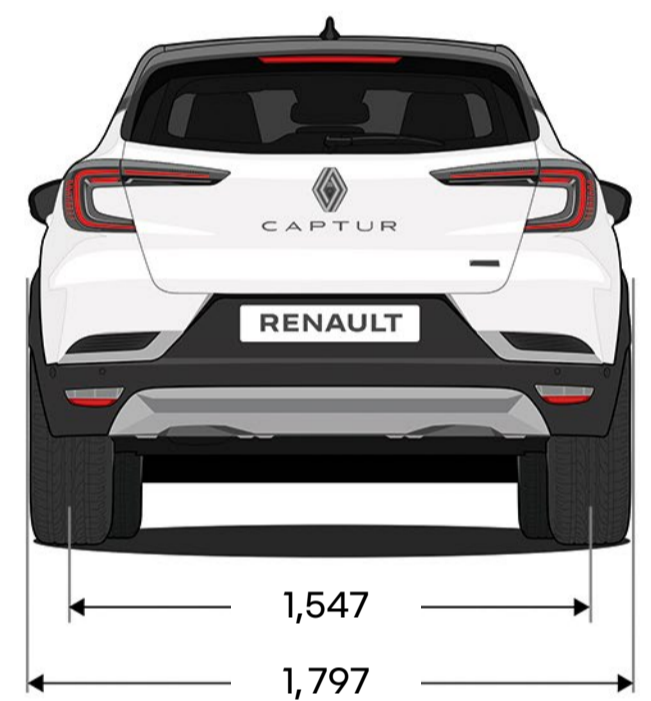
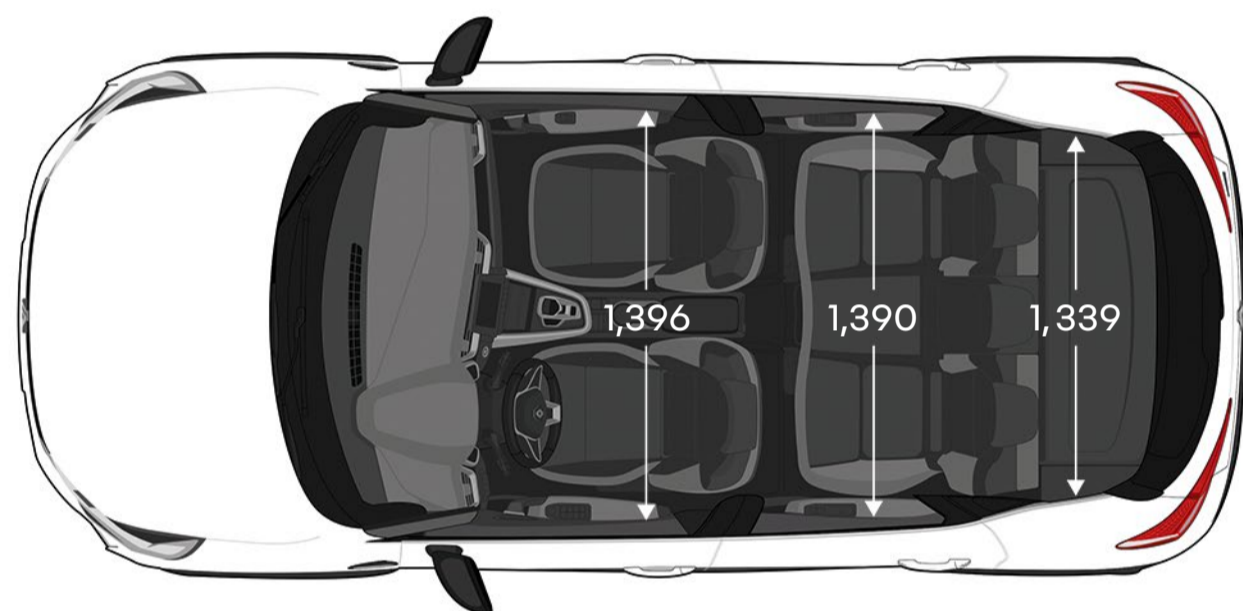
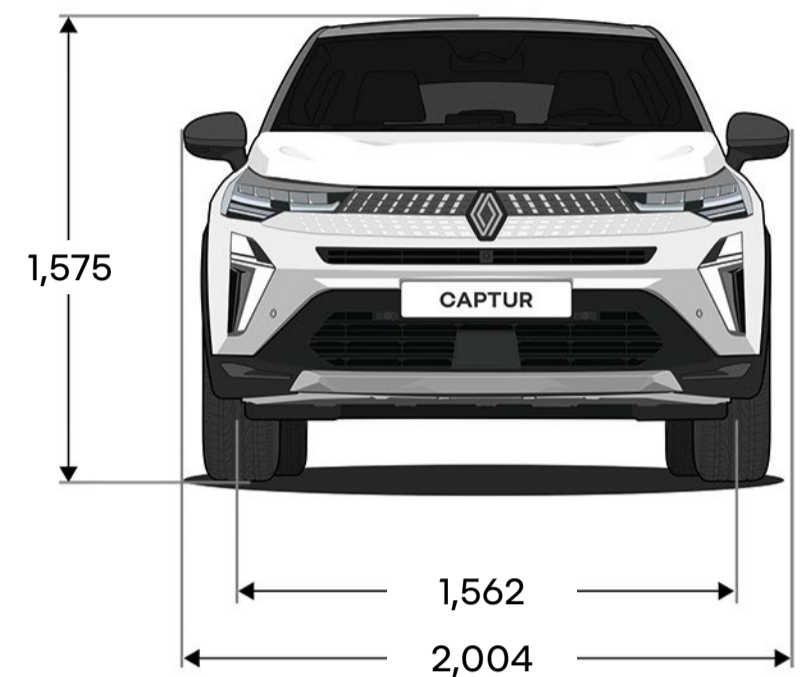
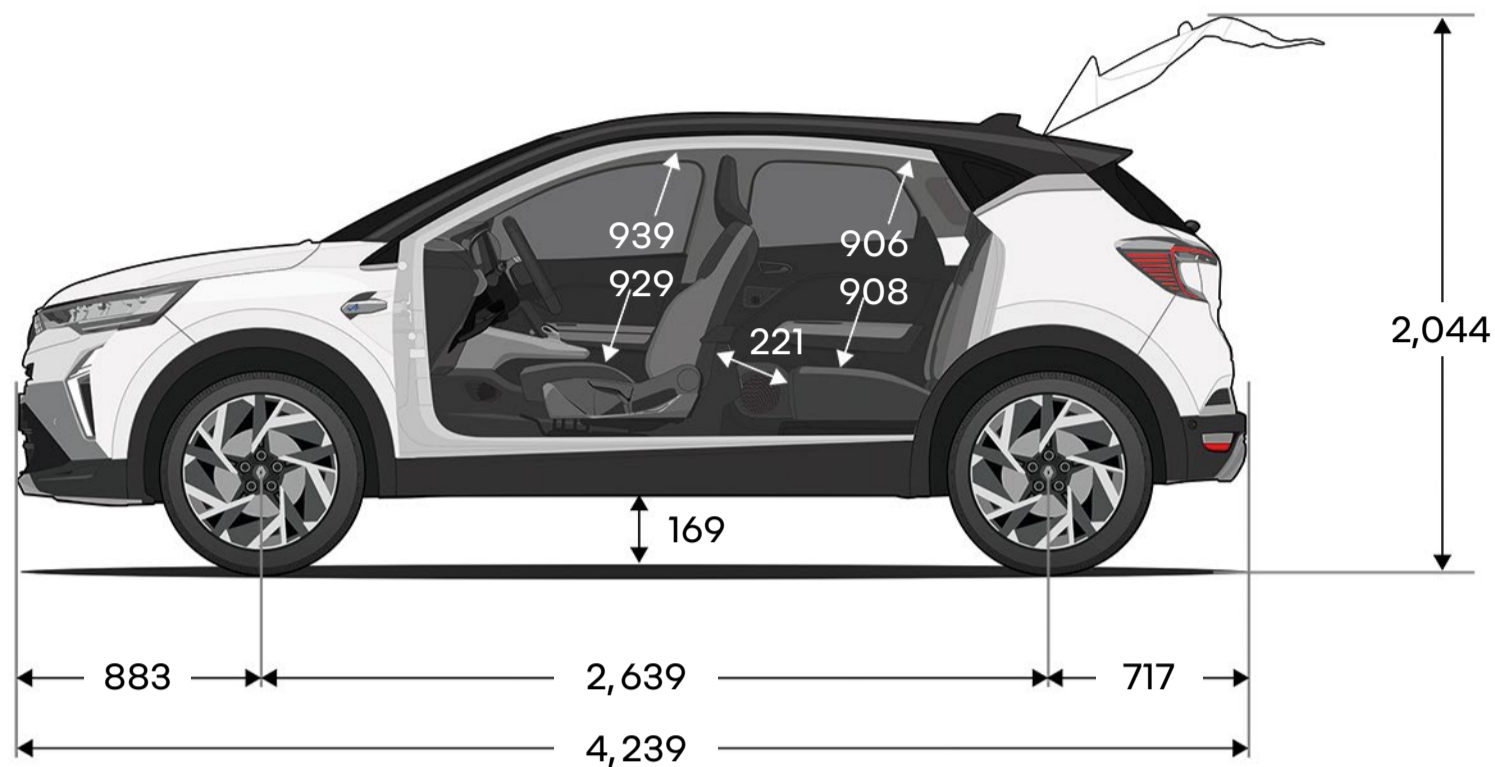

boot volume (in litres) ⁽¹⁾	petrol	E-Tech full hybrid
boot volume, bench seat in rear position	484	348
boot volume, bench seat in forward position	616	480
boot volume, bench seat folded down	1,596	1,458

dimensions in (mm).

(1) volume according to the VDA (ISO 3832) standard: the standard involves measuring the total volume of the boot using standardised shape and volume objects (200 mm x 100 mm x 50 mm = 1 dm³). Equivalent for petrol: 422,536 and 1,275 dm³ and for E-Tech full hybrid: 326,440 and 1,149 dm³

the human first program is a comprehensive safety programme developed by Renault in collaboration with researchers, experts and firefighters.

because road safety concerns all road users, whether they are pedestrians, cyclists, motorists, the human first program by Renault is committed to:

- 1. prevent accidents by developing safety equipment and advanced driver-assistance and safety systems**
up to 36 advanced driver-assistance systems/more than 60 safety features, up to 7 airbags, child seats (Isofix), Renault Fixe4sure solution / more than 2,000 safety-related patents filed since 1970
- 2. manage accidents once they have happened by drawing on innovations developed in collaboration with firefighters**
QRescue / Fireman Access / more than 5,000 firefighters trained over 10 years in 19 countries worldwide / around 400 cars donated per year for their training
- 3. reduce the number of accidents and their severity by investing massively in R&D**
safety score / safety coach / connected services / big data / artificial intelligence and cybersecurity systems

find out more about the human first program

Renault care service

We are always at your side to make the driving experience easier and save you time with the maintenance of your Renault: online quotes and appointments, fixed-price packages, maintenance contracts, insurance and assistance, personalised My Renault programme... Take advantage of our simple and fast solutions tailored to your needs.



Every precaution has been taken to ensure that the contents of this brochure were accurate and up-to-date at the time of publication. This document has been created using pre-production and prototype models. In line with its policy of continuous product improvement, Renault reserves the right to modify the specifications, vehicles and accessories described and featured at any time. Any such modifications are communicated to Renault dealers as quickly as possible. Depending on the country of sale, versions may differ and some equipment may be unavailable (standard, optional or accessory). Please contact your nearest dealer for the latest information. For reasons to do with the medium, the colours featured in this document may differ slightly from those of the actual paintwork or interior trim. All rights reserved. Reproduction in any format and by any means of all or part of this brochure is prohibited without prior written authorisation from Renault.

Publicis - photo credits: C. Pausania, © Renault Marketing 3D-Commerce - June 2024.
Renault s.a.s, a French simplified joint stock company with a share capital of €533,941,113.00 / 122-122 bis avenue du Général Leclerc - 92100 Boulogne-Billancourt Cedex, France - registered on the Trade and Companies Registry (R.C.S.) of Nanterre under number B 780 129 987 / tel.: 0806 00 20 20.

Renault recommends  **Castrol**

